



CHINA INTERNATIONAL MARINE CONTAINERS (GROUP) LTD

2017



茶葉





---

---

---

---

---

---



茶葉





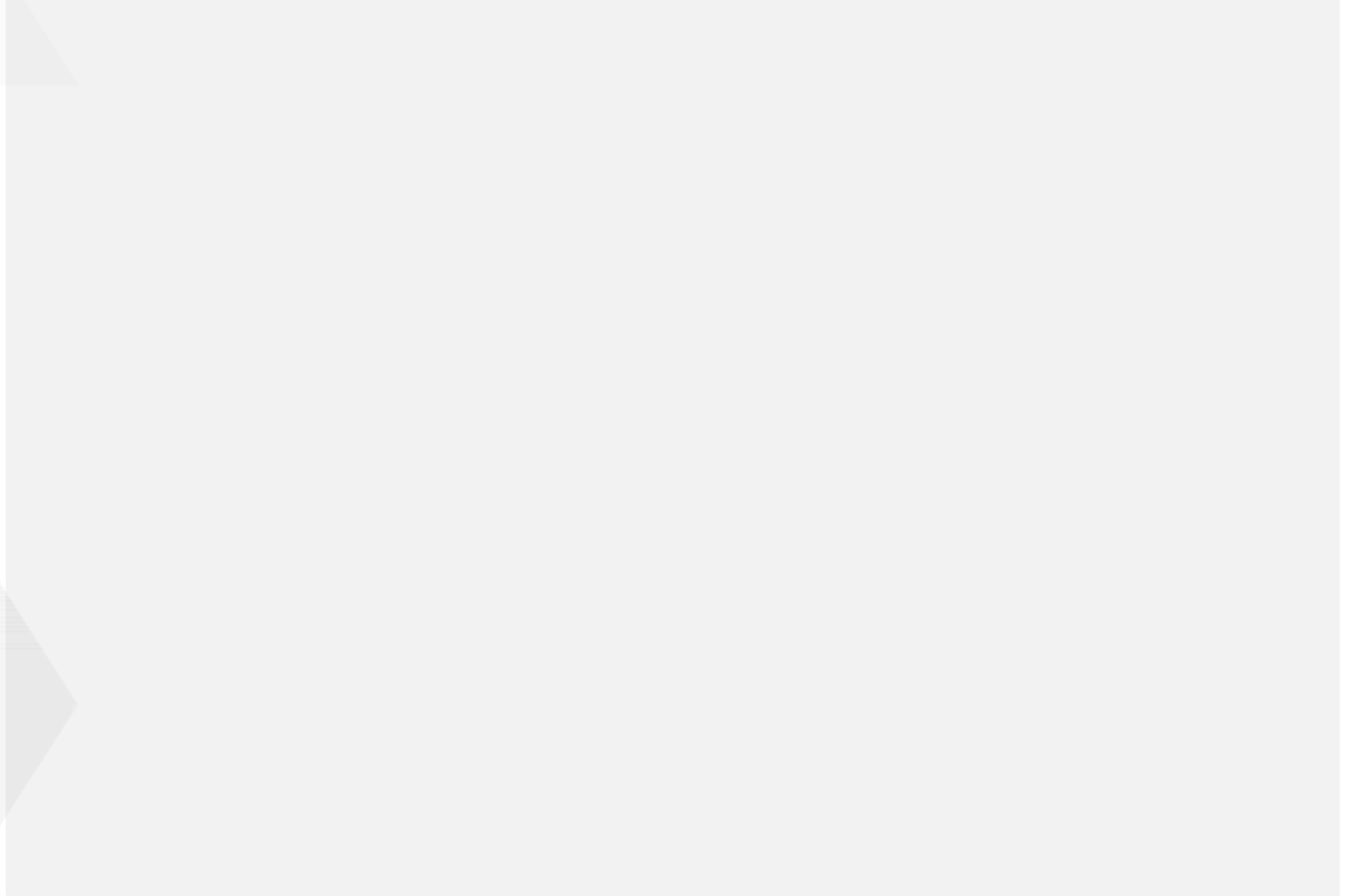



The overall trend  
of the industry  
is positive.



38.59%

9,719,601

7,013,354

56.96%

568,016

361,893

39.90%

81,468

58,231

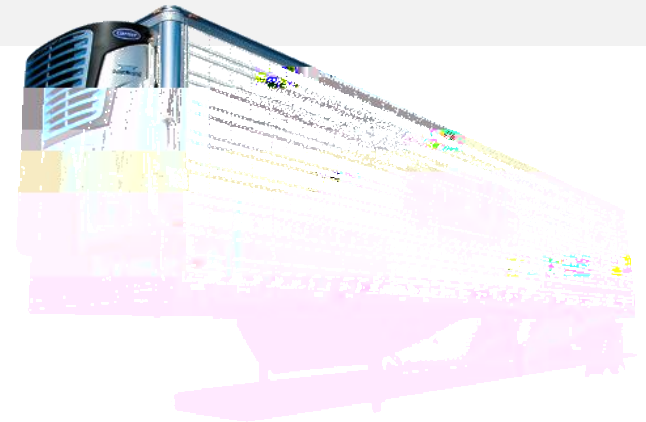

---

---

---

---

---

---

---

---

---

---





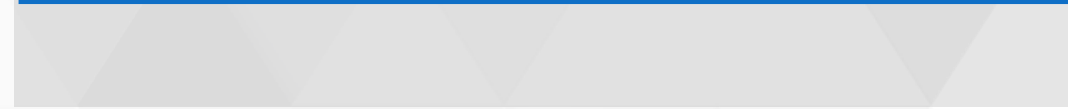

---

-67.21%	1,214,509	3,703,689
-	-550,421	-3,988

---

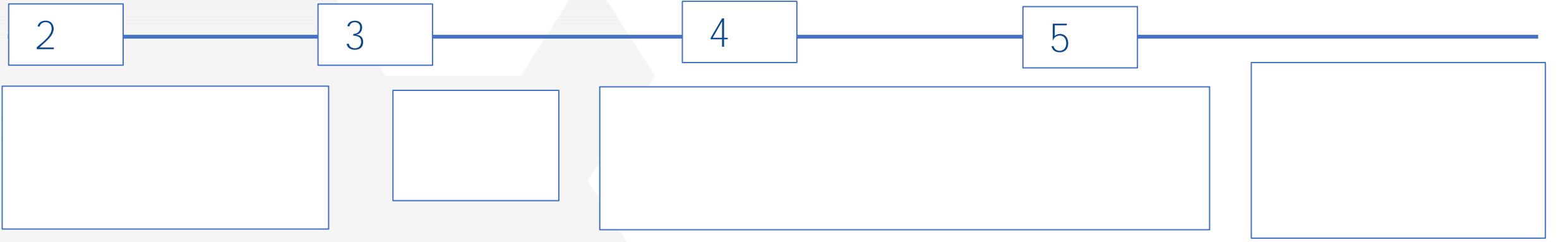





16.55%	3,751,202	3,218,617
-16.21%	57,340	68,434

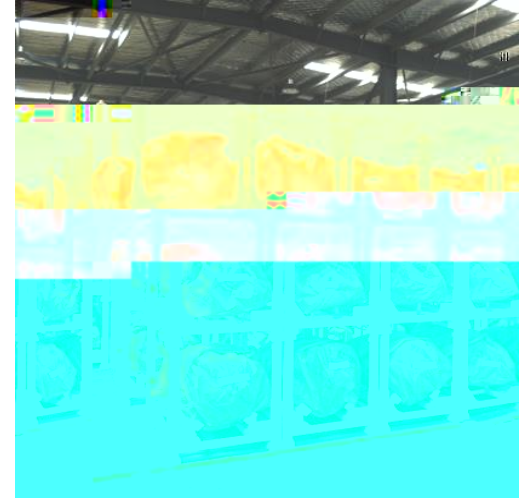
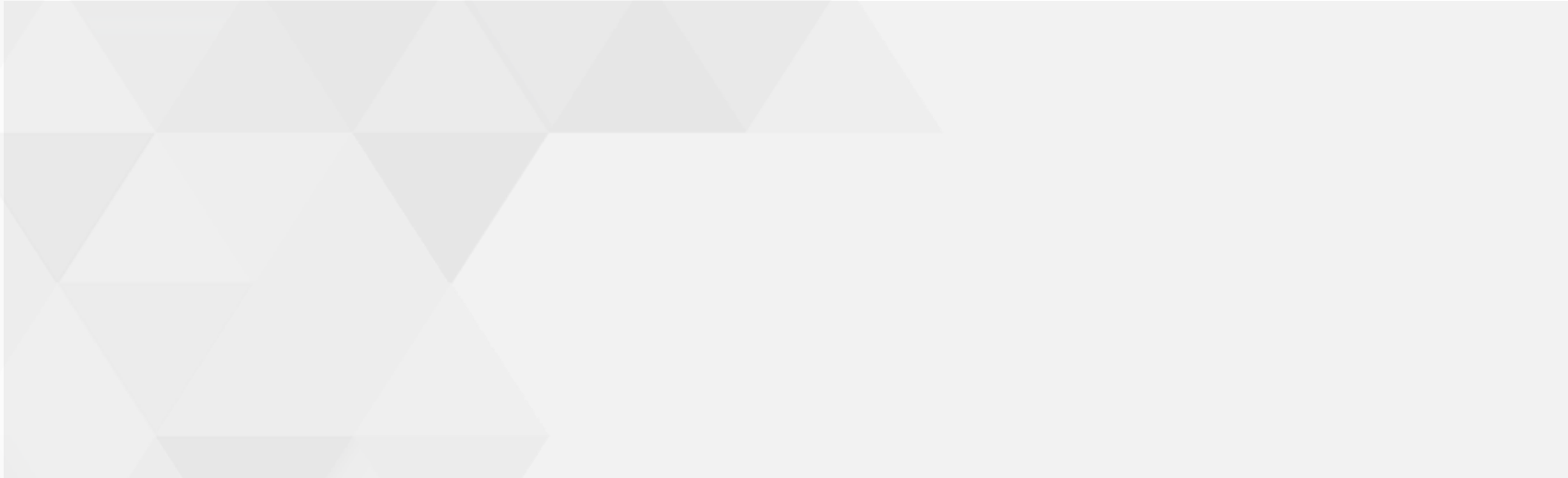





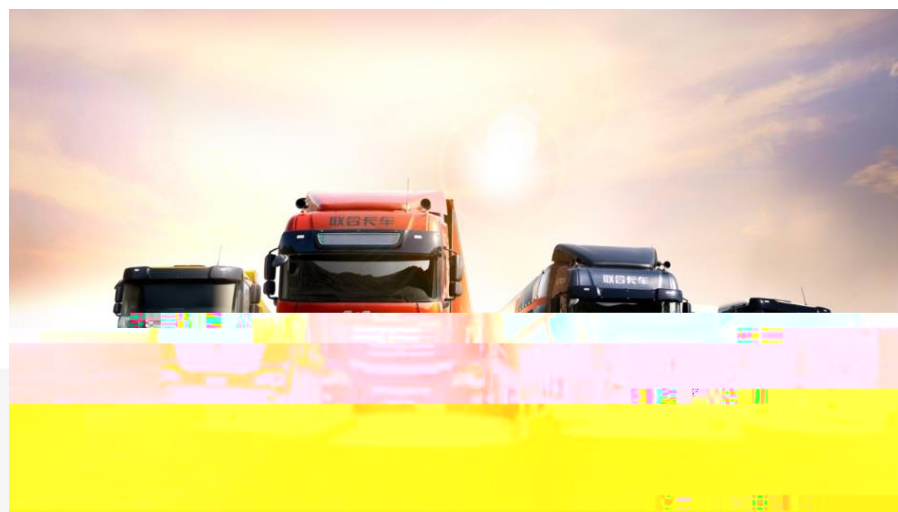

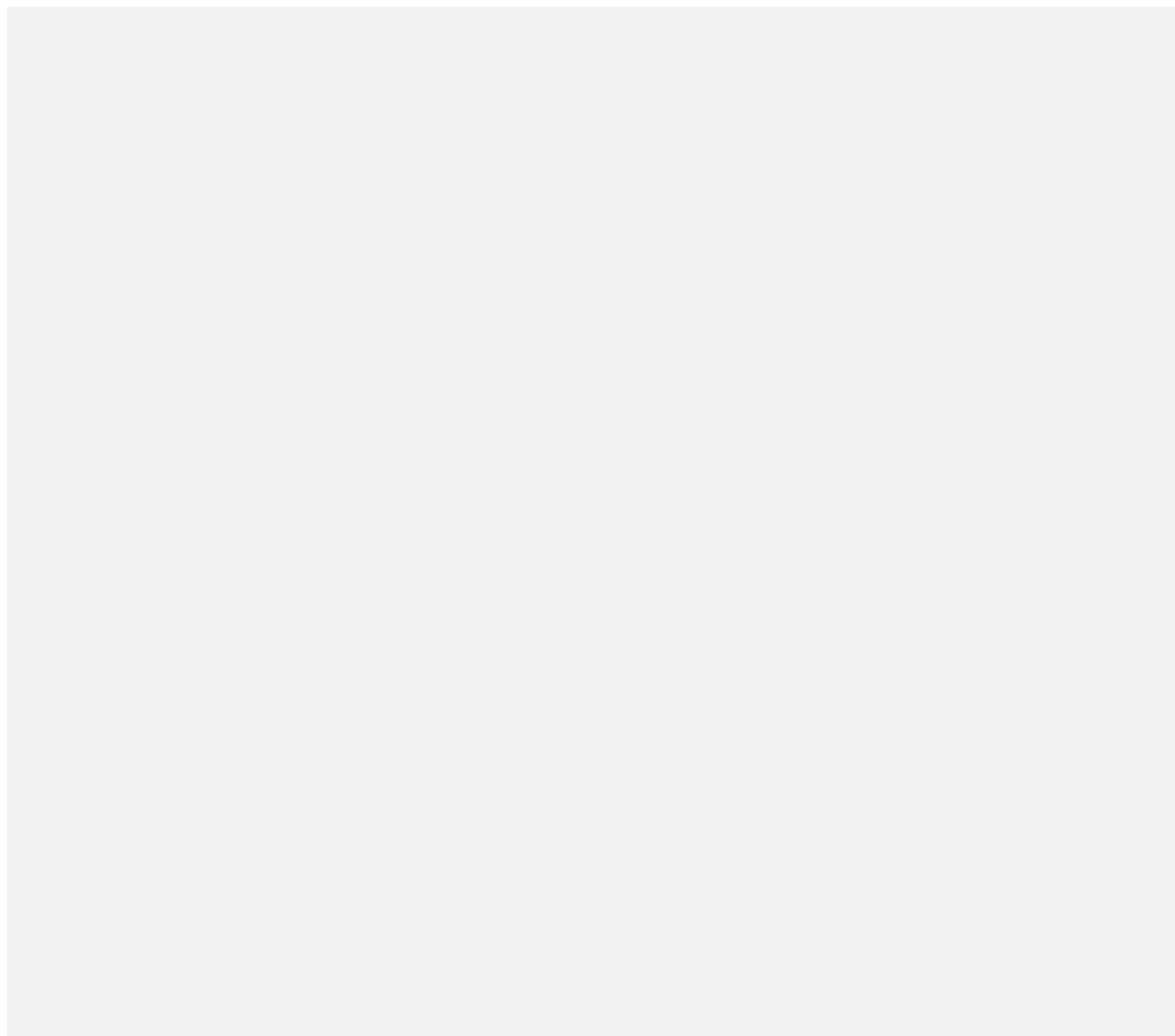



-5.71%

297,664

315,698

52.04%

65,035

42,775

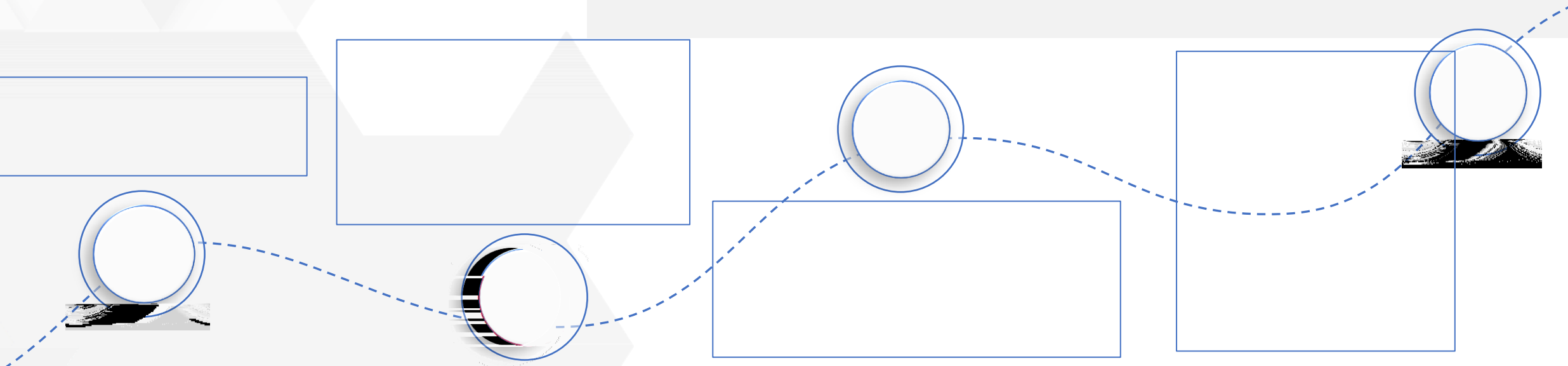
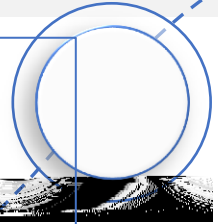
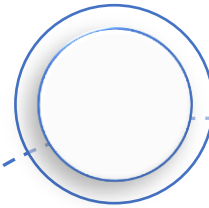
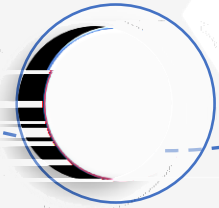
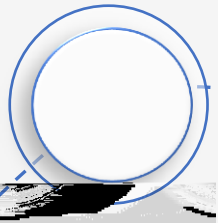
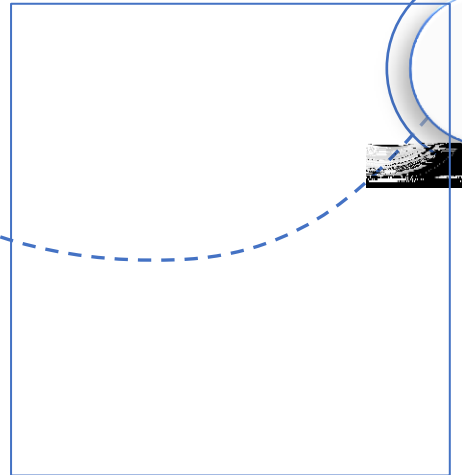
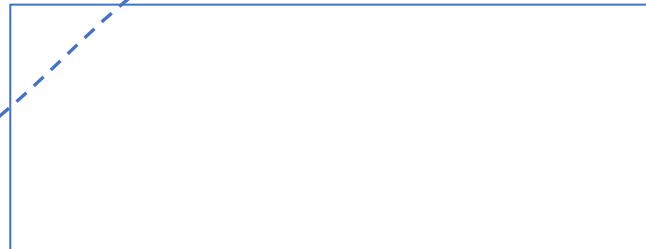
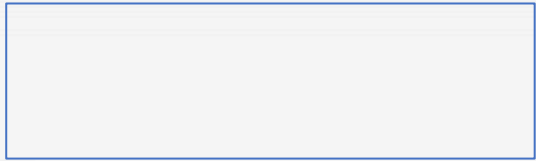

---

3.02%	1,148,040	1,114,356
13.75%	516,097	453,708

---



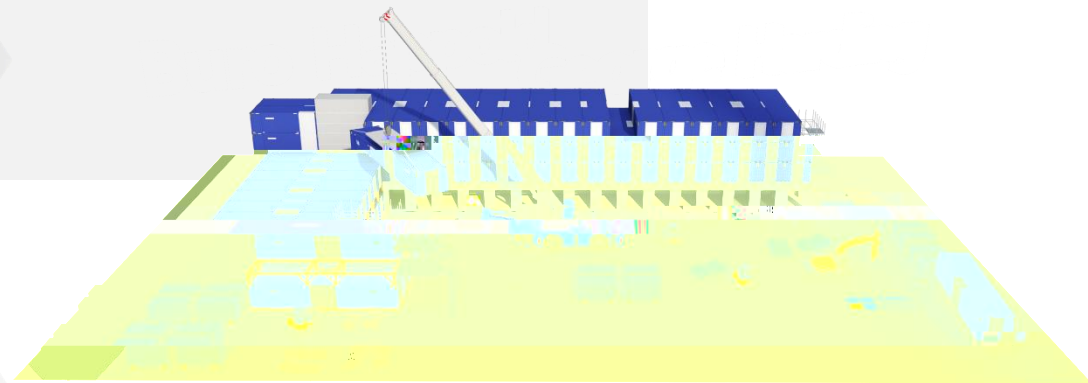







CHANG







### Gross profit margin of principle business (unaudited)

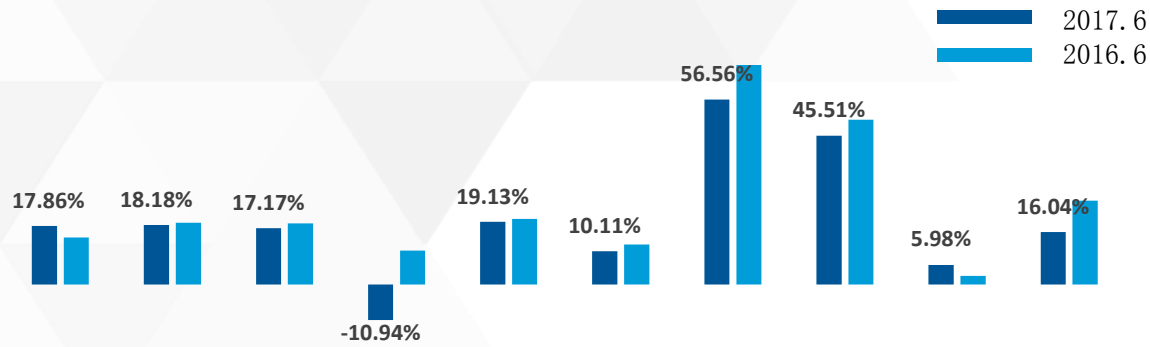

### Gross profits of principle business (unaudited)

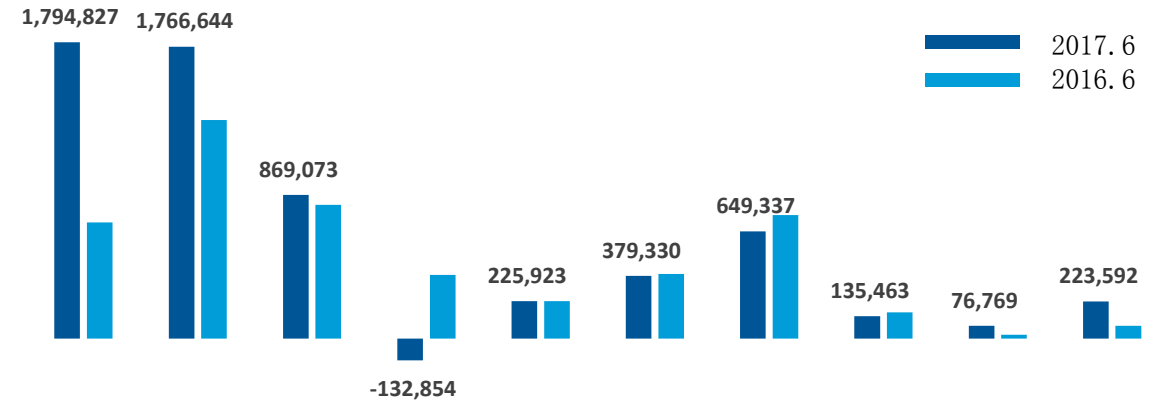

### Net profits of principle business (unaudited)



CHANG



